

BRAHMA CART

SPEC SHEET

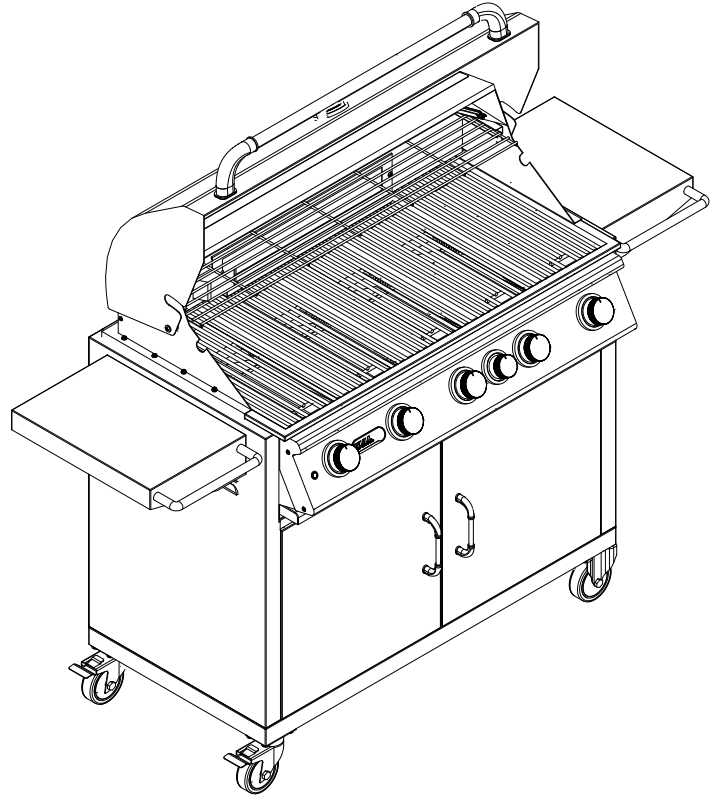

ISOMETRIC VIEW

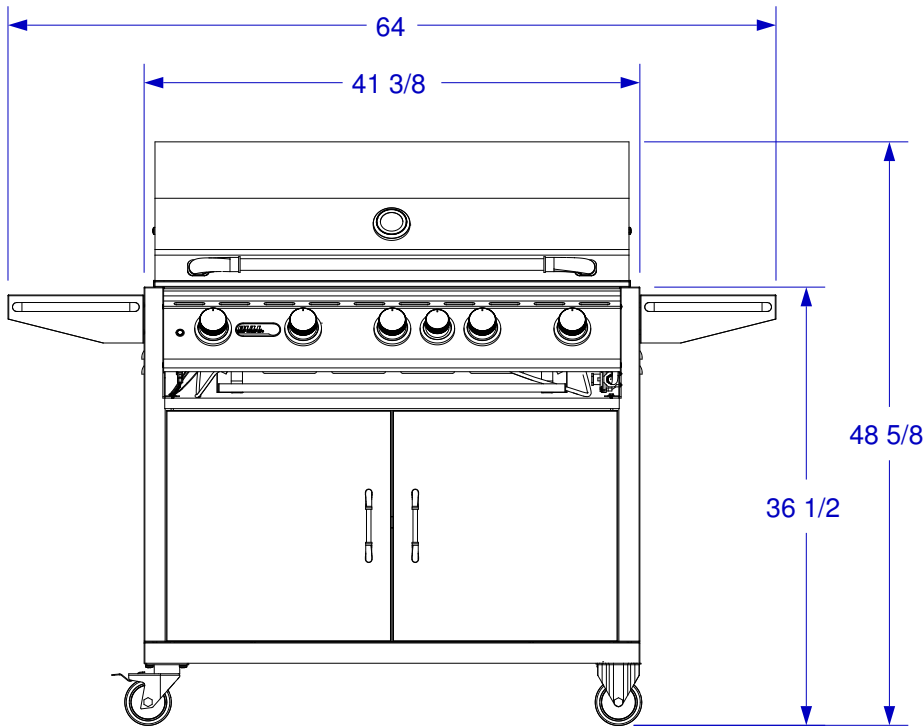

FRONT VIEW

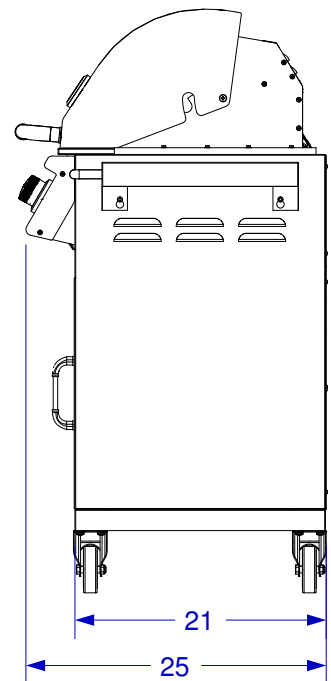

RIGHT SIDE VIEW

NOTES:

1. SCALE: 3/4" = 1'-0"
2. REVISION: 09/2013